

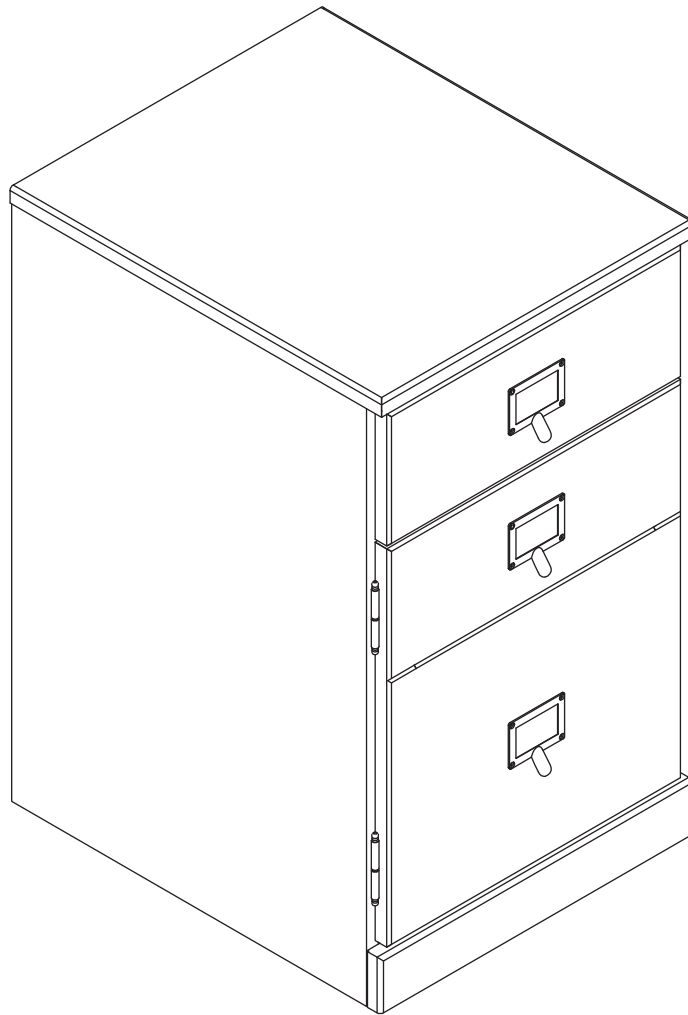

PRODUCT NAME: Original Home Office™ One Drawer CPU Cabinet

ITEM NUMBER: MO232

ASSEMBLED DIMENSIONS : 27"H x 16"W x 19"D



Prevent accidentally discarding small parts or hardware. Retain all carton contents until assembly and installation are complete.

▲ Assemble in location for intended use.

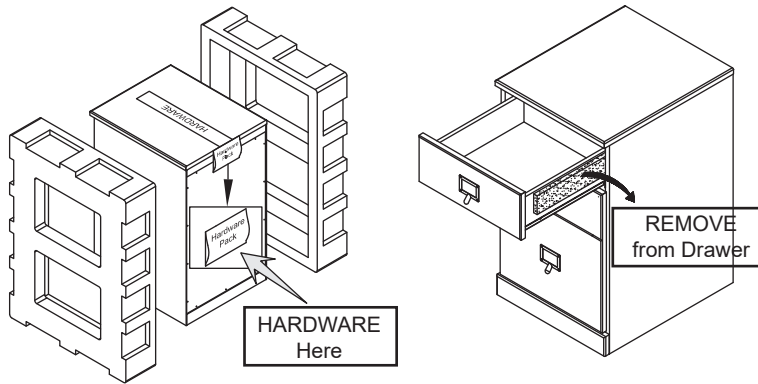

REQUIRED TOOLS:
Phillips Screwdriver

-Two person assembly suggested.

Remove all parts, hardware and protective packaging from carton and carefully arrange on a clean, level, padded surface.

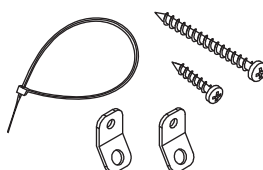
Ltr.	Qty.	Hardware Included
A	1	 <p>Wall Anchoring Anti-Tip Kit See Page 3</p>



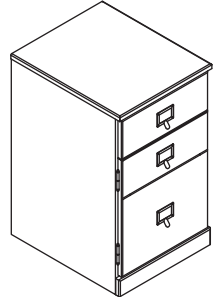

WARNING
Tip-Over Hazard
Prevent tipping accidents. Anchor your furniture.
ANCHORING HARDWARE INCLUDED

Ltr.	Qty.	Components
B	1	 <p>Cabinet (B)</p>

	<p>Cleaning and Care</p>
	<p>Periodically dust with a soft, dry cloth. Prevent finish damage: do not use alcohol based cleaners or polishers.</p>

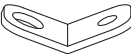

WALL ANCHORING HARDWARE (ANTI-TIP)

Ltr.	Qty.	Hardware Included	
A	1		Large Screw
B	1		Small Screw
C	2		Bracket
D	1		Retention Belt



Installation:

1. Place furniture against wall at desired location then locate and mark a Wall Stud behind unit.
2. Corresponding to Stud location, attach one Bracket (C) to back of unit using Small Screw (B).
3. To keep hardware out of view after installation, attach remaining Bracket (C) **INTO WALL STUD** with Large Screw (A) 2 inches below Bracket attached to back of unit.
4. Move unit into place, align Brackets then connect both using Retention Belt (D).
5. Confirm Belt is securely laced and locked.

