



CASA
Florentina[™]

PRODUCT NAME: Gabriele Corner Cabinet

ITEM NUMBER: SF021

DIMENSIONS OF ITEM ASSEMBLED:

85 1/2"H x 44"W x 30"D

For Assembly Purposes:

- Requires 2 or more people to assemble.
- Requires a screwdriver.



800.367.2810
www.ballarddesigns.com

This item is not intended for commercial use.





Made in Italy.

Updated: 8/10/2016

Page 1 of 4

2010 Ballard Designs, Inc.

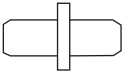
Check to ensure that you have the following:

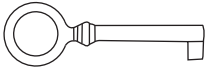
Ltr.	Qty.	Hardware Included	
A	8		Screws
B	2		Brackets
C	12		Shelf Pins
D	2		Anti Tip Kits
E	2		Keys (One key is extra)

NOTE: When unpacking, lay the parts on a padded surface such as the packaging provided.

Be sure to locate all hardware before throwing away any packaging.

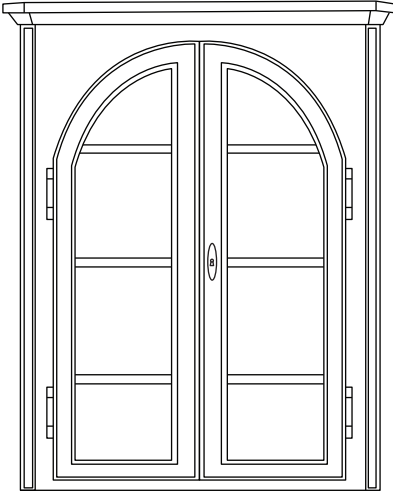
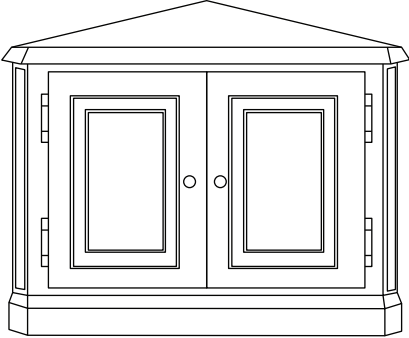
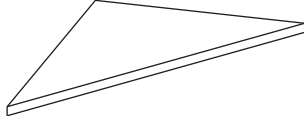
Ltr.	Qty.	Part List	
F	1		Corner Hutch (F)
G	1		
H	4		Shelves (H)

STEP 1: Hutch Assembly

Place the Corner Hutch (F) on top of the Corner Base (G). Connect the Hutch to the Base by centering the Brackets (B) evenly over the Hutch and the Base with two screws holes on each side, and securing into place using the Screws (A).

NOTE: Attach the Brackets near the edges and in the center for the best support.

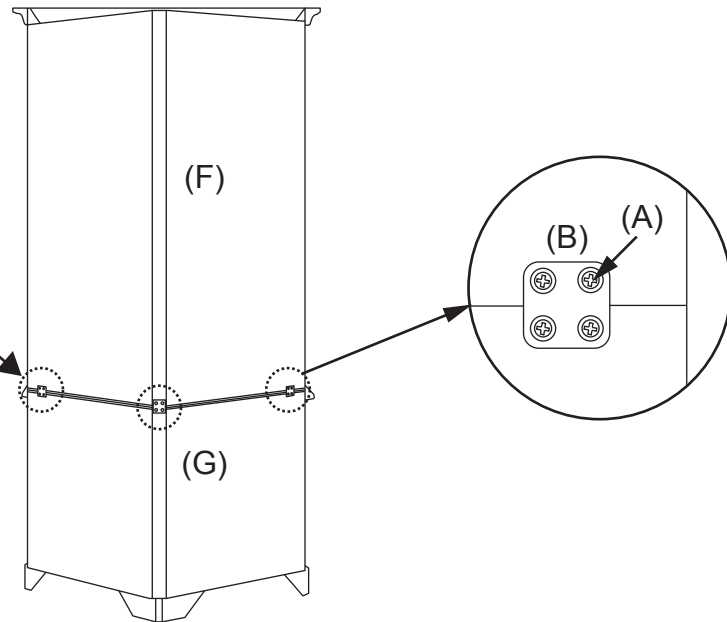



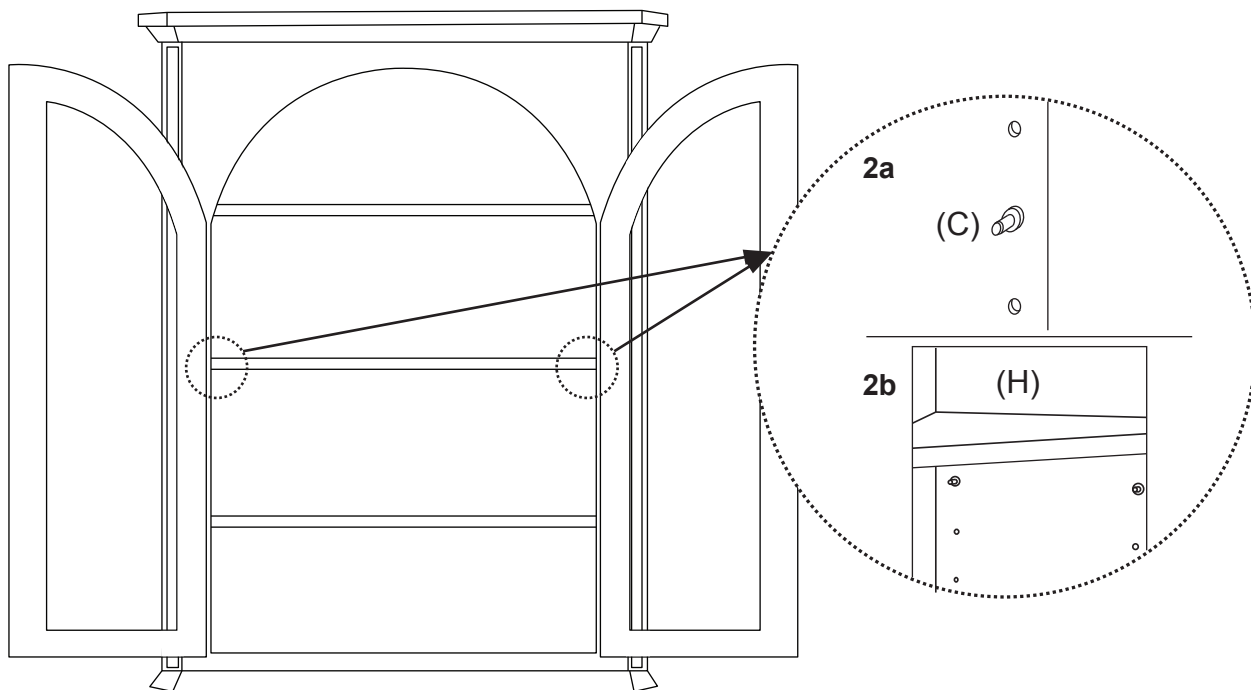

STEP 2: Shelf Assembly

Place Shelf Pins (C) at the desired shelf heights. Then place the Shelves (H) on the Pins. Three Shelves go in the Corner Hutch and one Shelf goes in the Corner Base.

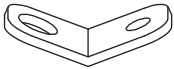

ANTI TIP INSTALLATION: PART D

Ltr.	Qty.	Hardware Included	
I	2		Small Screw
J	2		Large Screw
K	4		Bracket
L	2		Retention Belt

Attach a Bracket (K) to the back of the Corner Hutch (F) in each top corner with the Small Screws (I) through the smaller holes. Then screw the remaining two Brackets (K) into the wall studs with the Large Screws (J) 2 inches below the Brackets attached to the furniture. Align the Brackets vertically and string in the Retention Belts (L). Confirm Straps are securely laced and locked.

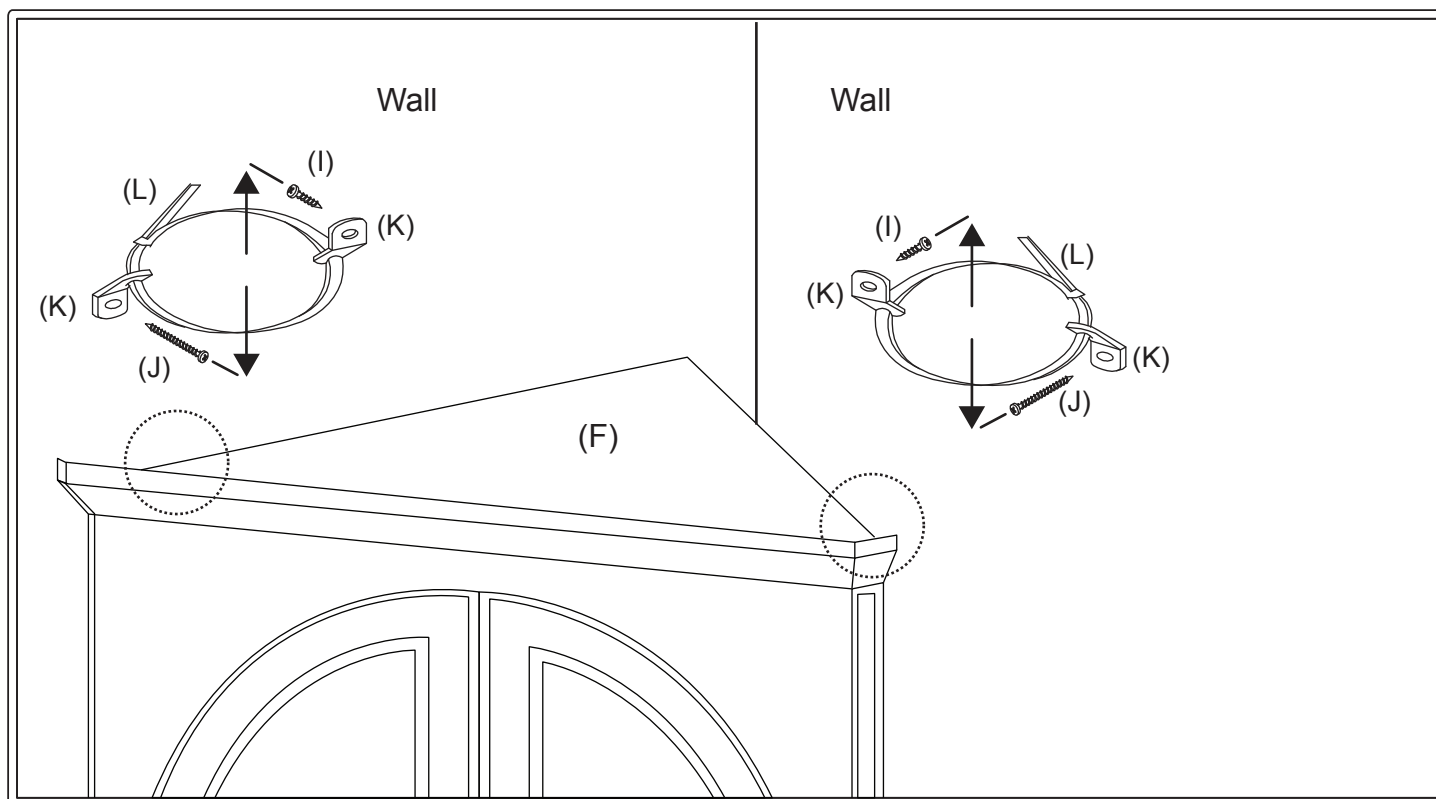

Cleaning & Care:

DO NOT use alcohol based products or spray polisher as they can damage the finish.

Dust with soft cloth. One to two times monthly, apply beeswax polish as needed.

Finish can be affected by heat or extended contact with oils or wine.