

SUZANNE KASLER

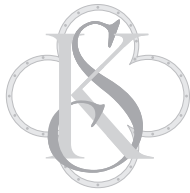

BALLARD DESIGNS



Customer Service: 800-367-2810
Online: www.ballarddesigns.com

PRODUCT NAME: SK Directoire Chaise

ITEM NUMBER: SO618

ASSEMBLED DIMENSIONS: 41"H x 23"W x 68"L









Prevent accidentally discarding small parts or hardware. Retain all carton contents until assembly and installation are complete.

PRODUCTS ARE NOT INTENDED
FOR COMMERCIAL USE.
UPDATED: 1-21-2021

MADE IN CHINA
Page 1 of 3

⚠ Assemble in location for intended use.

| Ltr. | Qty. | Hardware Included | |
|------|------|---|-------------------------|
| A | 2 |  | Allen Bolts (M6 x 45mm) |
| B | 2 |  | PVC Washers |
| C | 2 |  | PVC Covers |
| D | 2 |  | Flat Washers |
| E | 1 |  | Allen Wrench |
| F | 2 |  | Wheel Cover |

REQUIRED TOOLS:
Allen Wrench (Included)

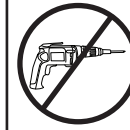

DO NOT USE POWER TOOLS FOR ASSEMBLY
Aluminum is a soft metal.
Over-tightening will strip threads
and/or break parts.

-Two person assembly suggested.

Remove all parts, hardware and
protective packaging from carton and
arrange on a clean, level surface.

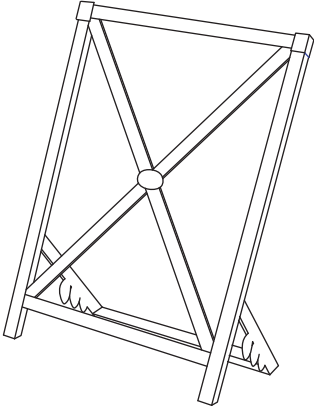
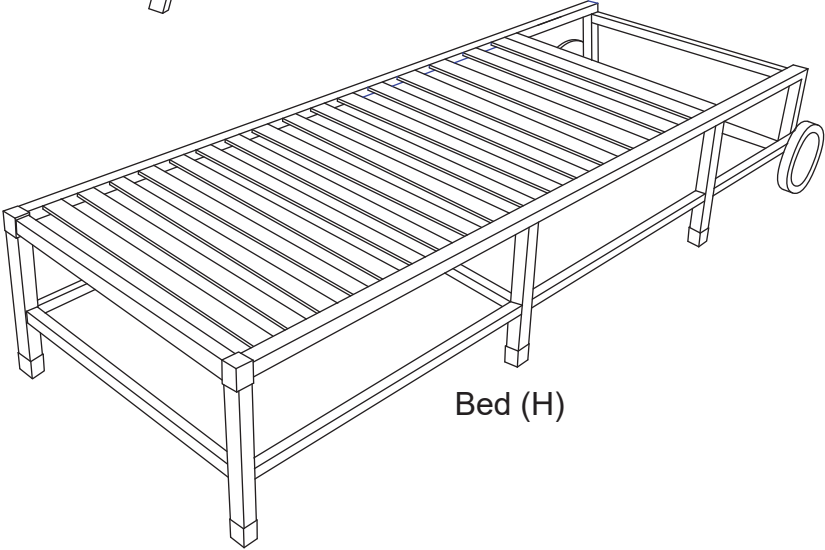
| Ltr. | Qty. | Components | |
|------|------|--|--------------|
| G | 1 |  | Backrest (G) |
| H | 1 |  | Bed (H) |



Customer Service: 800-367-2810
Online: www.ballarddesigns.com

| | |
|--|--|
|  | <p>DO NOT USE POWER TOOLS FOR ASSEMBLY Aluminum is a soft metal. Over-tightening will strip threads and/or break parts.</p> |
|--|--|

Place Backrest (G) into Bed (H), align holes then insert Allen Bolt (A) with Flat Washer (D). Place PVC Washer (B) between Backrest and side of Bed (this permits Backrest to freely move for adjustment). Once both Bolts are in place, use Allen Wrench (E) to fully tighten each. **DO NOT OVER TIGHTEN! Threads may be stripped.** Cover both Bolt heads with PVC Covers (C). Add Wheel Cover (F)

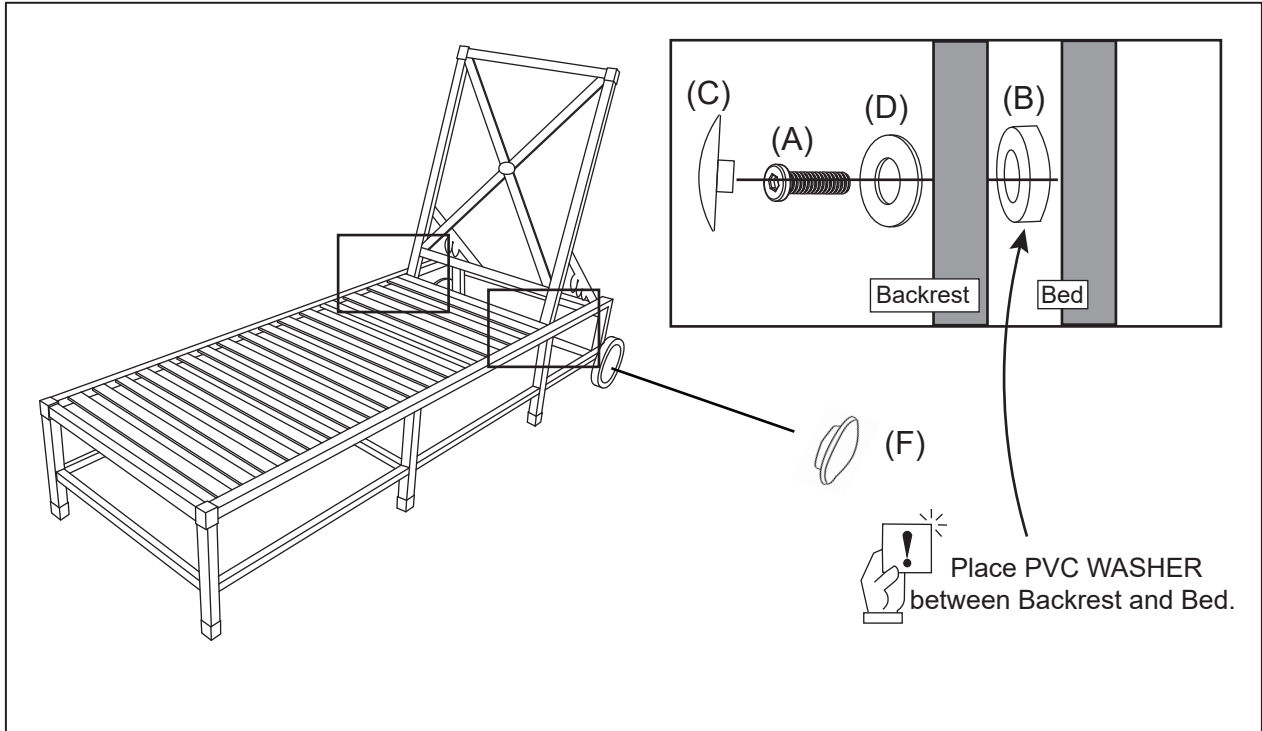

| | |
|---|--|
|  | <p>Cleaning and Care</p> |
| | <p>Periodically clean with mild soap and water. Prevent finish damage: do not use acidic or alkaline cleaning products.</p> |



Customer Service: 800-367-2810
 Online: www.ballarddesigns.com