

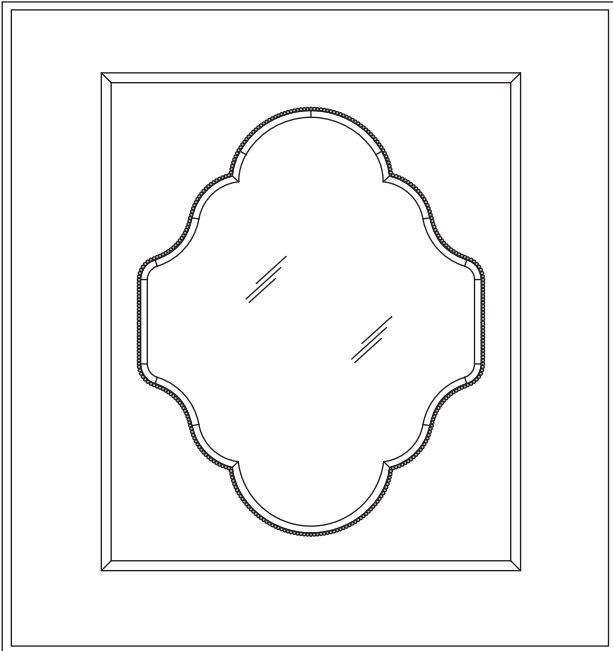



PRODUCT NAME: Charme Mirror
ITEM NUMBER: WN247
ASSEMBLED DIMENSIONS : 38"H x 32"W x 1.25"D

REQUIRED TOOLS:
Phillips Screwdriver, Level, Pencil,
Drill with 3/8" bit
-Two person assembly suggested.

Remove all parts, hardware and protective packaging from carton and carefully arrange on a clean, level, padded surface.

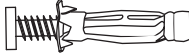

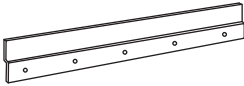
| Ltr. | Qty. | Hardware Included | |
|------|------|---|----------------|
| A | 1 |  | Expansion Bolt |
| B | 3 |  | Wood Screws |
| C | 1 |  | French Cleat |

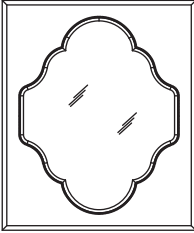
| Ltr. | Qty. | Components | |
|------|------|--|------------|
| D | 1 |  | Mirror (D) |



WARNING
Falling Hazard

Wall Decor is **HEAVY** and requires adequate support.
Wall Brackets must be firmly attached to **WALL STUDS**.



Cleaning and Care

Periodically dust with a soft, dry cloth.
Protect surfaces to prevent damage.
Do not use alcohol based cleaners or polishers.

SAFETY NOTICE: At least one hole in Cleat must be centered on and attached to a Wall Stud.

STEP 1: Determine location for Mirror (D) then locate and mark Wall Stud(s) directly behind Mirror. Use a Level to position French Cleat (C) on wall, being certain to center at least hole over a Wall Stud. For holes on a Stud, drive Wood Screw (B) directly into Stud. For holes where no Stud is present, see inset for using Expansion Bolt (A).

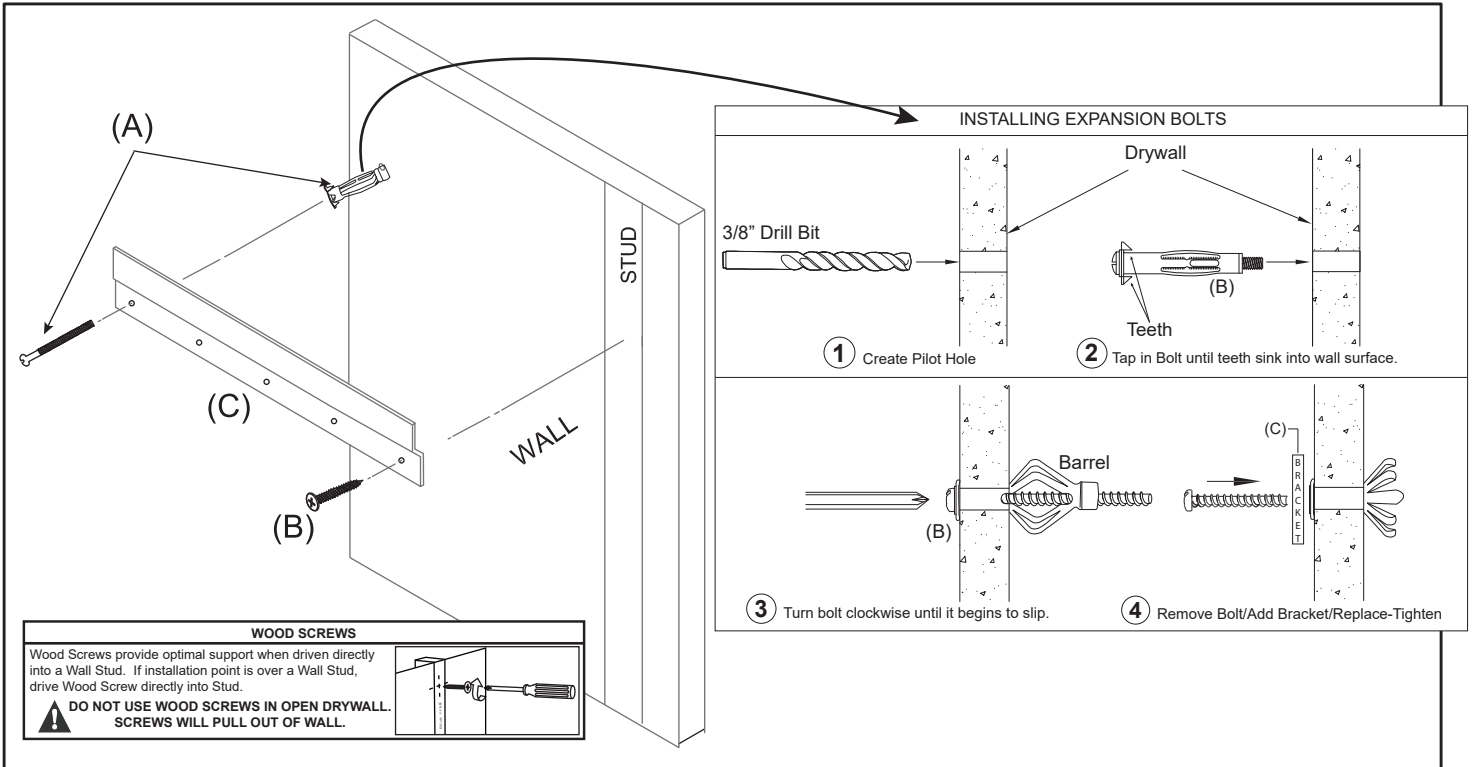

STEP 2: With Cleat (C) secured to Wall, carefully lift Mirror (D) and lower onto Cleat. (Fig. 1). Components are designed to fit together using Mirror's weight to lock them into place. (Fig. 2)

